

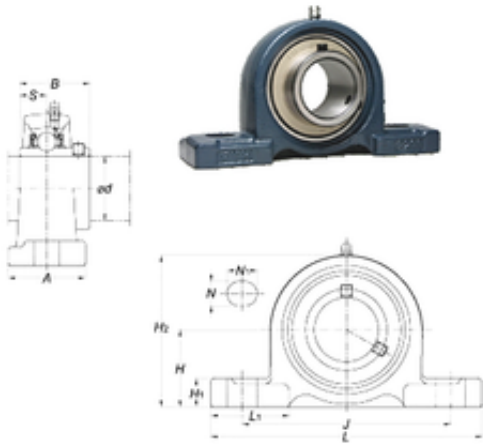

NTA PRECISION AXLE CORP.

FYH UCP207 bearing units



Bearing No. UCP207

Bore Diameter	35 mm
Width	42,9 mm
d	35 mm
A	48 mm
B	42,9 mm
H	47,6 mm
H1	16 mm
H2	93 mm
J	127 mm
L	167 mm
L1	51 mm
N	17 mm
N1	21 mm
S	17,5 mm
Bolt (G)	M14
Weight	1,6 Kg
Basic dynamic load rating (C)	25,7 kN
Basic static load rating (C0)	15,4 kN
Category	Mounted Units & Inserts
Inventory	0.0
Manufacturer Name	FYH BEARING UNITS
Minimum Buy Quantity	N/A
Weight / Kilogram	0
Product Group	M06110

UCP207 Bearing 2D drawings and 3D CAD models